



Please read the user manual carefully before riding

Electric Scooter

L9

User Manual

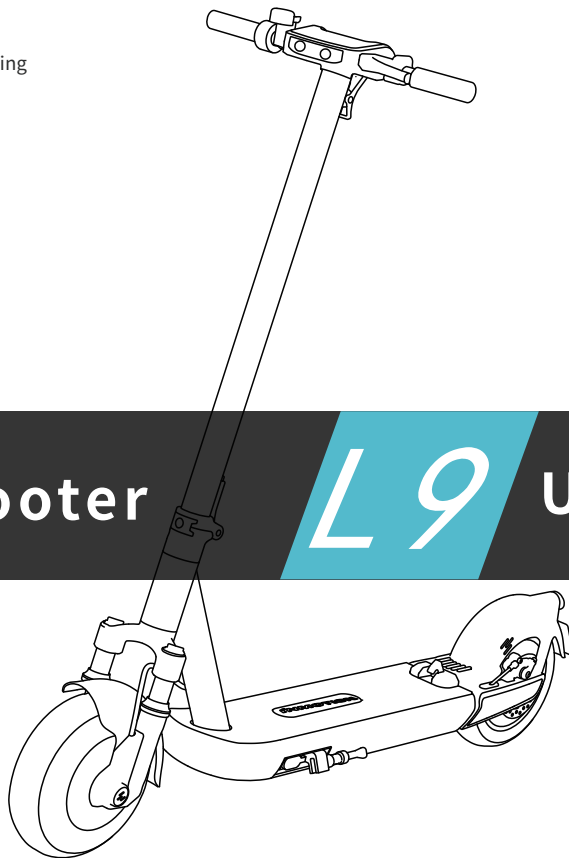

Inmotion Technologies Co., Ltd.  
[www.inmotionworld.com](http://www.inmotionworld.com)

***i*NMOTION**

Welcome!

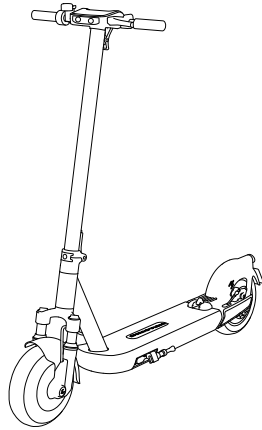

L9

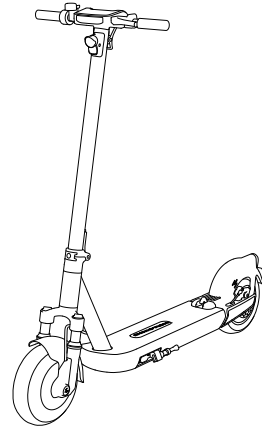

L9G

All pictures in this manual are for reference only, please refer to the actual product.

Thank you for choosing Inmotion Electric Scooter L9 (hereinafter referred to as scooter).

This scooter is easy to fold and easy to carry, It is also a sport, it is a sports entertainment equipment with stylish technology

# Contents

1	Safety instructions .....	1
2	Packing list .....	4
3	Product function diagram .....	5
4	How to assemble .....	7
5	Initial use .....	8
6	Connect the charger .....	9
7	How to ride .....	9
8	Potential safety hazards .....	11
9	Folding and carrying .....	13
10	Daily care and maintenance .....	14
11	Table of Parameters .....	16
12	Trademarks and legal notices .....	18
13	Warranty .....	22

# 1 Safety instructions

1. The electric scooter L9 is a product designed for personal urban transportation, which has the property of a means of transportation, and the safety risks which all means of transportation may have.
2. Follow the tips and warnings in this manual can reduce risks, but it cannot eliminate all risks. Please keep in mind that when you use a scooter, you may be at risk of injury or death due to loss of control, collision, and falls. The scooter is only suitable for the hard pavement above, it is recommended to use it in alternately closed pavement environment (such as inside the community, parks, special venues, etc.) Do not pass through places with obstacles and contacts. When entering an unfamiliar environment, be vigilant and slow down.
3. Please wear a helmet and protective gear when riding. Please use an approved bicycle, or scooter helmet.
4. For the first riding, please do not choose areas where children, pedestrians, pets, vehicles, bicycles or other obstacles and potential hazards may appear.
5. Please respect the right of pedestrians when riding. Avoid frightening pedestrians, especially the elderly, children, the disabled, and pregnant women. When approaching pedestrians from the rear, remind pedestrians and slow down when passing. Please abide by local traffic laws and regulations.
6. When riding in countries and regions where there are no laws and regulations related to electric scooters, you must strictly abide by the safety requirements for cyclists in this manual. Inmotion will not assume any responsibility for any property loss, personal injury, accident, or legal disputes caused by the user behavior that violates the safety tips in this manual.
7. Before lending your scooter to someone else, make sure that they have read this manual, watched the instructional video, and learned novice instruction. You are responsible for ensuring the safety of new riders. Please assist him / her to learn to use this product until he / she learns the basic operation of this scooter. Please ensure that each new rider wears a helmet and other protective gear.
8. Before ride it, please check and make sure no loose fasteners and damaged parts. If the scooter makes anabnormal noise or alarm sound,

please stop using it immediately and consult with your purchasing point or email to the manufacturer.

(service@imscv.com).

9. Please observe the road surface when riding, avoid obstacles, and smooth ground (including but not limited to wet ground, loose sand, stone ground, and ice surface).

10. In order to reduce the risk of injury, you must read and follow all "Caution" and "Warning" notices in this manual. This product is suitable for users aged 14-60 years old and weighing less than 140kg. Please comply with the following safety tips:

A. Those who are not suitable for riding this scooter include:

i. Persons affected by alcohol or drugs.

ii. Persons are unable to engage in vigorous physical activities due to illness.

iii. Unable to maintain balance.

iv. Persons whose weight exceeds the prescribed limit (please refer to the instruction manual "Model Parameter Table").

v. Pregnant woman.

B. Minors need to ride scooters under adult supervision.

C. Please abide by the local laws and regulations while riding. Do not ride scooters in areas prohibited by the local law.

D. For a safe ride, you must ensure that you can see the area in front, and you could be seen by others.

E. Whatever the reason, please do not ride the scooter when it is snowing, raining, slippery, muddy, or icy. Do not ride a scooter across obstacles (sand, stones, or roadblocks), which may cause a loss of balance or grip, and result in a fall.

F. Damages and losses due to water ingress are not covered by the warranty.

G. Please do not drive at night.

H. Please do not suddenly accelerate or decelerate. Please do not drive at a speed exceeding the limit of the scooter, otherwise, there may be a risk of runaway, collision, and falling.

11. Please do not try to charge your scooter when the charging port, charger, or power outlet is wet.

12. Make sure to use the original chargers from Inmotion to charge the scooter.

13. Only use parts and accessories approved by Inmotion. And do not modify your scooter. Modifications to the scooter may affect the operation of the scooter, resulting in serious injury / damage and an invalid warranty.

14. Children should not use scooters or play scooter parts. When riding, the car body vibration will cause the driver's body vibration.

15. It is recommended to park on flat and solid ground. If parking on a slope, the kickstand must face downhill to prevent overturning. Do not allow the scooter head to rush down to prevent the kick-stand support from closing under gravity and the vehicle toppling over. After putting down the kick-stand, please check whether the scooter body is stable and prevent the scooter (from sliding, wind or shaking) from tipping over. Do not park in busy areas. It is recommended to park near the wall. Please park the scooter on a flat road as much as possible.

16. In order to get better driving experience, it is recommended to maintain the product regularly.

17. Please read the user manual before charging.

18. Do not touch the brake parts of scooter, an injury may cause.

**This appliance contains batteries that are only replaceable by skilled persons.**

**Warning:**

For the purposes of recharging the battery, only use the detachable supply unit provided with this appliance.

 detachable supply unit required, Use only with <XVE, model XVE126-6300180> supply unit.

## 2 Packing list

L9

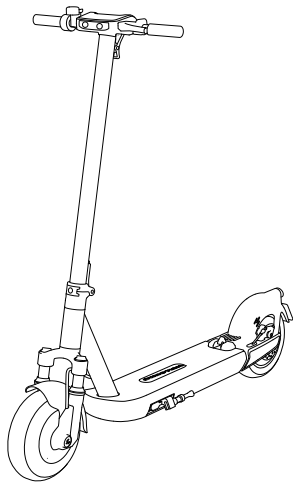

User Manual

Unboxing  
Instruction Manua

### Accessories

Power cable



Extended  
air valve

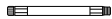

Screws



Allen wrench



Power adapter



Folding ring



Please carefully check whether the items in the packing box are complete and intact. If there is any part missing or damaged, please contact your point of purchase or email to manufacturer ([service@imscv.com](mailto:service@imscv.com)).



### 3 Product function diagram

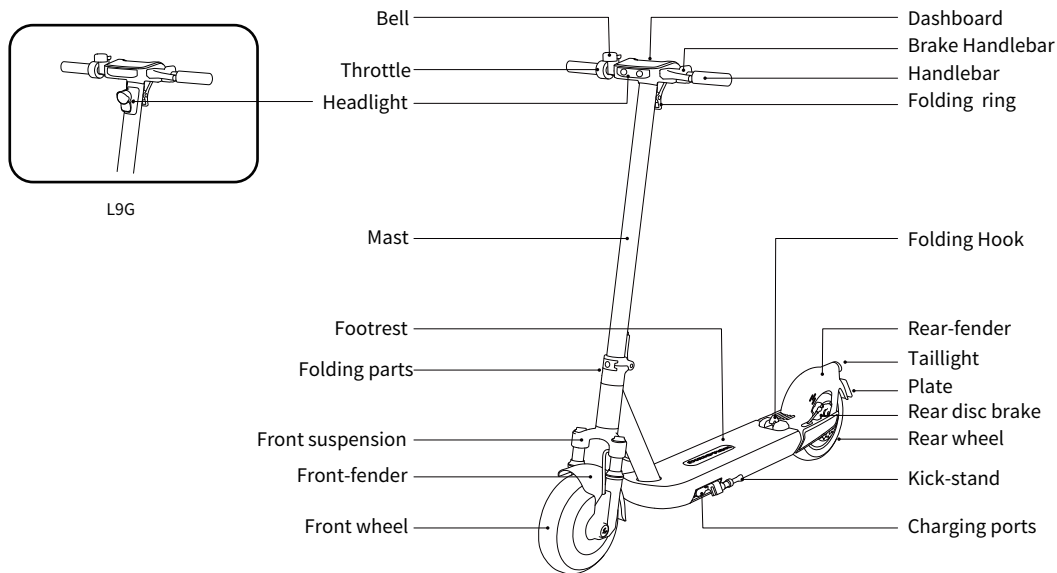

## Dashboard & Power on/off

---

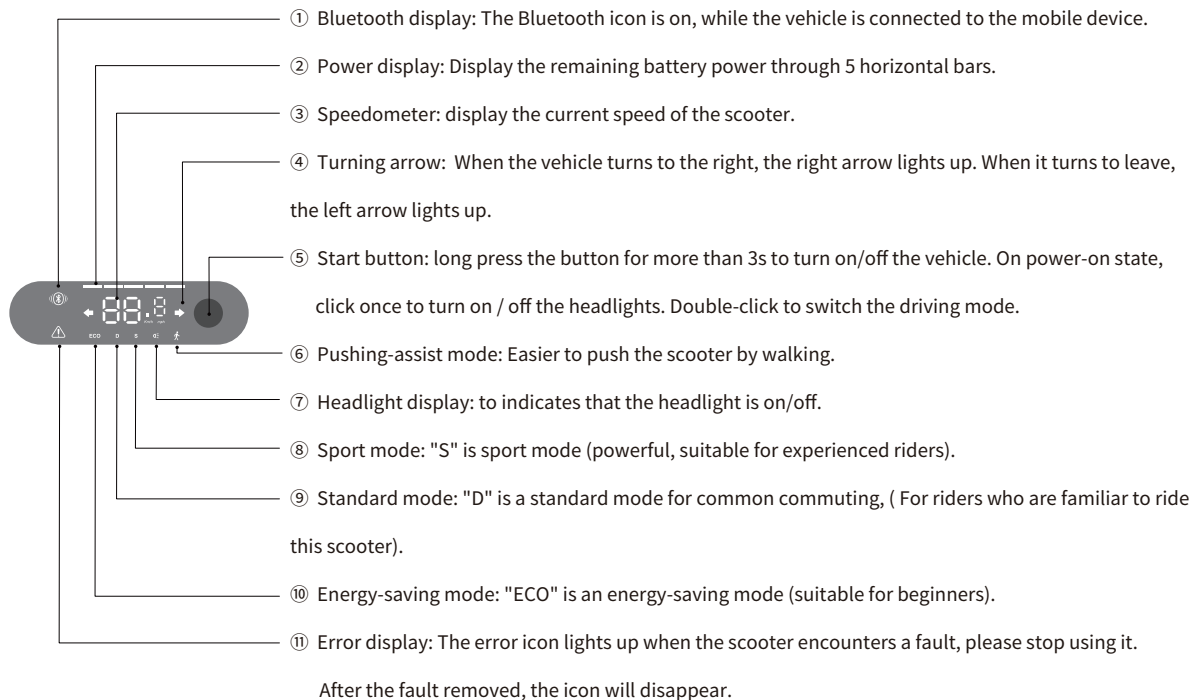

## 4 Scooter assembly

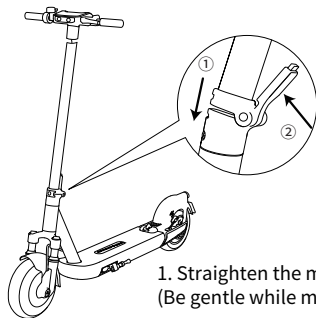

1. Straighten the mast of the scooter and fix it.  
(Be gentle while moving the handlebar components).

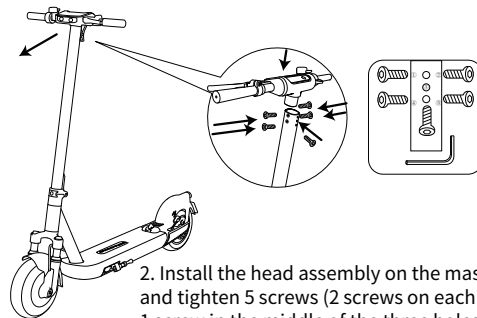

2. Install the head assembly on the mast, and tighten 5 screws (2 screws on each side, 1 screw in the middle of the three holes on the back of the mast) with the hexagon wrench provided.

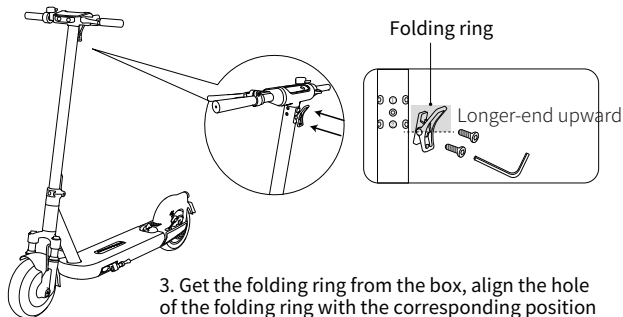

3. Get the folding ring from the box, align the hole of the folding ring with the corresponding position of the mast and tighten the 2 screws.

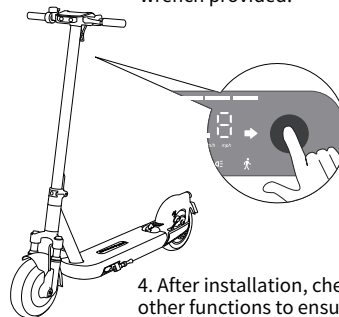

4. After installation, check the power on/off and other functions to ensure everything is normal. Check the screws again and tighten them before riding the scooter.

## 5 Initial use



There are safety risks when using scooters. Before the initial use, users must carefully read the safe driving guide through the APP. For safety consideration, the new scooter is not activated, and there will be intermittent beep prompts after booting. Before activation, the speed of the scooter was very low and all functions could not be used. You need to install the APP on your mobile device (Bluetooth 4.0 and above), connect your scooter via Bluetooth, and activate your scooter as prompted by the APP.

Scan the QR-code to download Inmotion App.

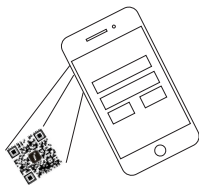

1. Install Inmotion App on Android or iOS devices, register it, and log in.

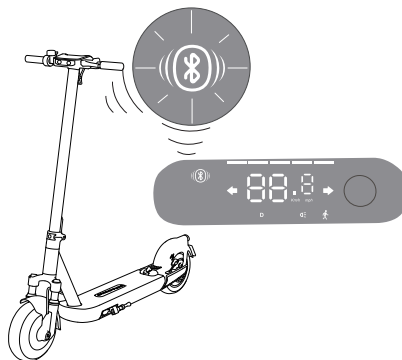

2. When the scooter turned on, by default, Bluetooth enters the status of the waiting connection. Connected the scooter with APP. The icon is always on once the connection is successful, and the user can start using the APP to operate.

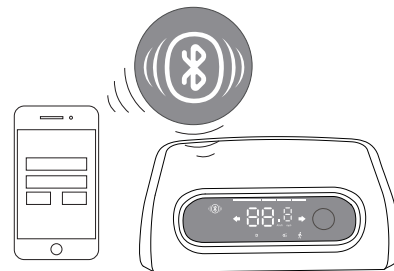

3. Follow the tips from App and Activate the scooter, and learn how to drive safely. Now, you can start using your scooter, and check its status and function and operate via the APP.

## 6 Connect the charger

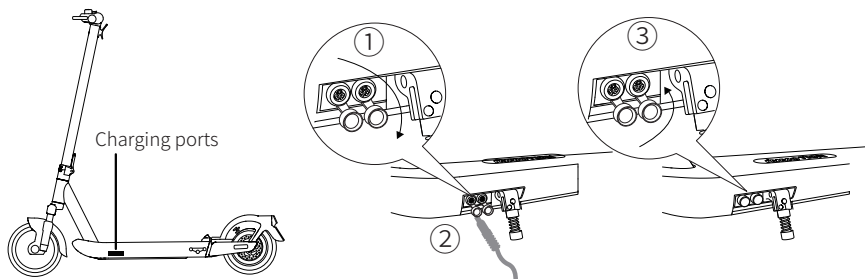

Steps: Open the cover of charging ports and plug in the charger. Cover back after charging.

### Warning



Use the original charger, otherwise the battery may be damaged or cause danger! Do not connect the charger when the charging port or the charging cable is wet! If the battery is damaged or gets into water, it is forbidden to charge or continue to use the battery!

## 7 How to ride

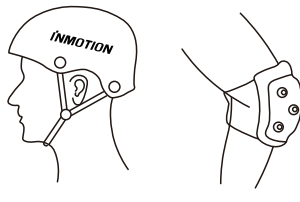

Please take safety measures when riding, such as: wearing sports clothes, wearing helmets, knee pads, elbow pads, and other protective tools.

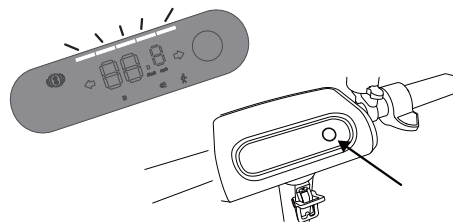

1. Long press the power on/off button until the ring lights are fully illuminated. Check the battery indicator. If the remaining battery is too low, please charge immediately.

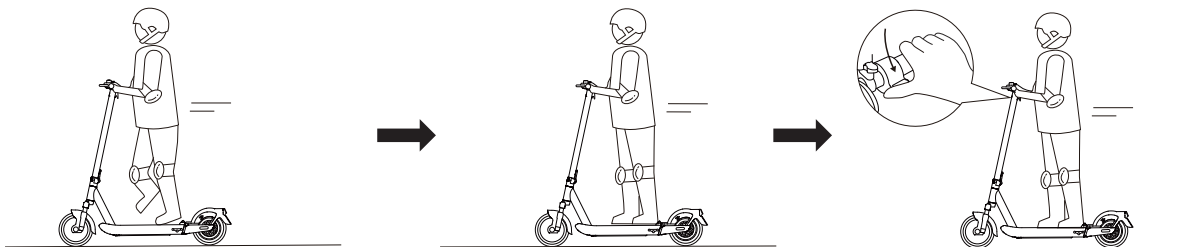

2. Stand on the footrest with one foot, the other foot kicked back on the ground and began to glide. The motor can only be started after the vehicle speed reaches 3km / h. Gently press the throttle on the right handlebar, the scooter can ride slowly, hold the handlebar to control the riding direction (similar to riding bicycle).

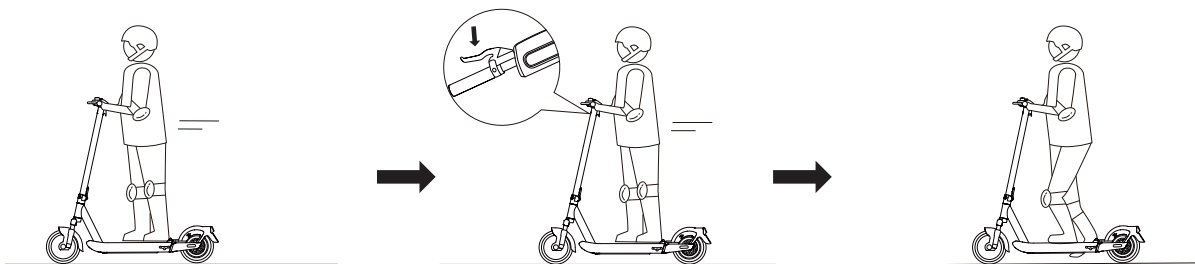

3. Gently press the throttle on the right handlebar to accelerate, but please do not be too fast. Hold the brake to make the scooter slow down (Try to avoid emergency braking) . When the scooter stops or taxis slowly, get down one foot first, then get off normally.



To avoid accidental touch, by factory default, the motor and throttle will be started only when scooter be in the taxi state, and the throttle does not work after the scooter stops.

## 8 Potential safety hazards

⚠ Failure to follow these instructions may result in serious injury.



Avoid riding in the rain.

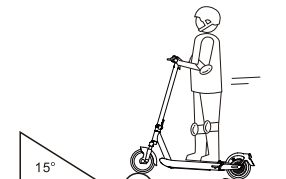

Do not ride at a high speed when pass by the bumps and potholes, it's a good recommendation to keep slow to medium speed on a rough road. (5-10km/h) .

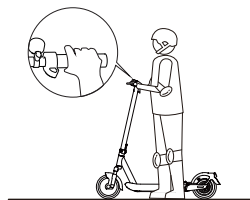

Do not press the throttle when pushing the scooter.

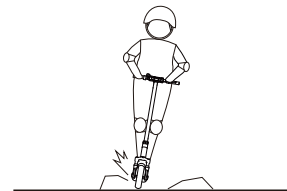

Pay attention to road conditions and avoid obstacles while riding.

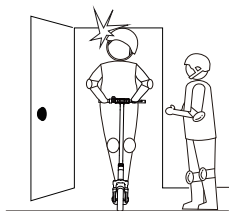

Avoid hitting high obstacles such as door frames and elevators.

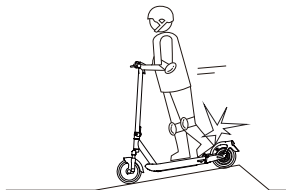

Do not step on the rear fender.

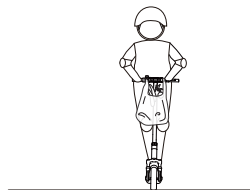

Do not hang heavy objects on handlebars and other parts of the scooter.



Do not ride at the Non-standard postures, such as: riding on with one foot on the footrest or one hand on the handlebar.

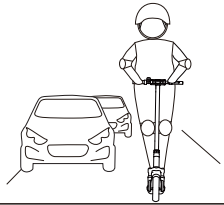

Do not ride it in public street if not allowed by the laws.

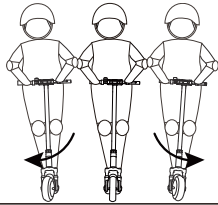

Do not turn the handle greatly on high-speed riding.

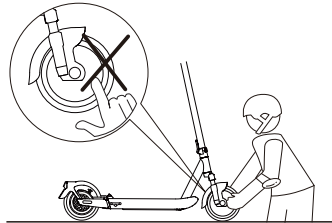

Do not touch, if the motor causes high temperature and heat during operation.



Do not hands-free from handlebars while riding.



Don't go straight through the puddle, please go around it at a low speed.

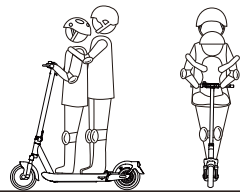

For one rider only, do not ride with other people or holding the child. Not suitable for pregnant women.

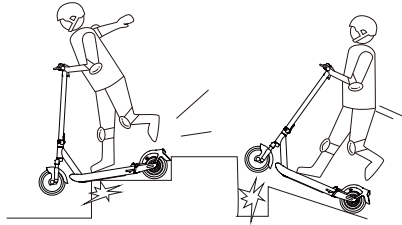

Do not ride scooters up and down steps or jump obstacles.



Do not using a cell phone or headphones on riding.



## 9 Folding and Carrying

Fold unlock button

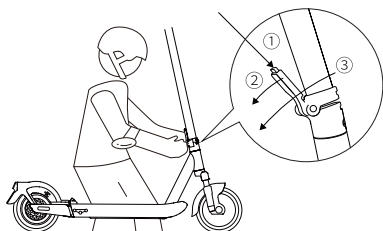

Power off the scooter, one hand hold the mast, and the other hand press the fold-unlock button and pull back the folding wrench. Then fold the mast backward.

Press down the folding ring

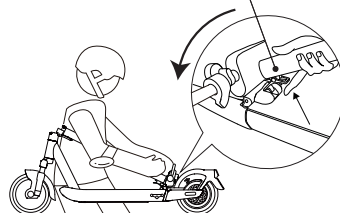

After folding down the mast, press down the folding ring, and align it with the hook on the rear end of footrest, release the folding ring to hook it successfully.

Press down the folding ring and lift up the mast

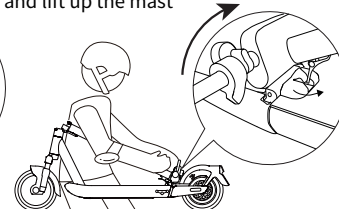

To unfold the scooter. Press down the mast, at the same time hold the folding ring until release it from the hook, and straighten the mast to ensure the folding wrench back to its position tightly.

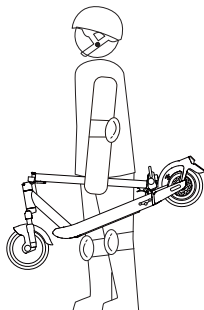

You could carry it after folding.

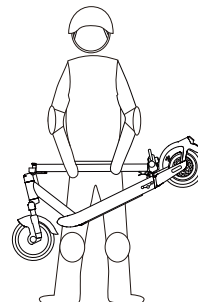

You could carry it after folding.

# 10 Daily care and maintenance

## Cleaning and storage

Wipe the mainframe of scooter with a soft damp cloth. If any stains which are difficult to clean, brush repeatedly with a toothbrush and toothpaste, then clean with a soft damp cloth.

Tips: Do not use alcohol, gasoline, kerosene, or other corrosive, volatile solvents to clean your scooter. These substances may damage the appearance and internal structure of the body of the scooter. It is forbidden to spray the scooter with a pressure water-gun or water pipe.

## Warning

Before cleaning, make sure the scooter is powered off, and the charging cable has been unplugged and the rubber cover of the charging port has been fastened. Otherwise, it may cause damage to electronic components or the battery. When the scooter is not in use, please place it in a bright and dry place. Do not park the scooter outdoors. Sun exposure or extreme temperature conditions (overheating and too cold) will accelerate the aging of plastic parts and may lead to a reduction in battery life.

## Battery dis-assembly and maintenance

Please don't take the battery out if not necessary. It's a little complicated to dis-assembling the battery, and which may affect the operation to the body of the scooter. And it's better to let the professional staff install the tires. Any improper operation may cause the body of scooter to be unstable or with other failures:

1. Do not use battery made by 3rd parties if without authorization, otherwise there may be safety risks.
2. Recharge the scooter with the original charger, otherwise, there may be a risk of damage or fire.
3. Do not touch the battery contacts, and do not dis-assemble or pierce the case of battery. Avoid the short circuit caused by metal objects touching the battery contacts, otherwise, it may cause battery damage or personal injury.
4. It is forbidden to put the battery into fire, otherwise it may cause the battery to fail, overheat, or even risk of fire.
5. Please fully charge the scooter before store it, which is helpful to prolong the battery life. Do not exceed the limit of specified temperature (refer to the table of parameter) while store and charge the battery.
6. The Improper disposal of used batteries may seriously pollute the environment. Please comply with the local regulations when disposing of the battery. Do not discard this battery as one's desire.

The battery in good condition can maintain a good operating state even after driving for many miles. Please re-charge the battery on time, to avoid the battery is completely draining. At the indoor temperature of 22 ° C, the battery has the best battery life and performance. However, at the temperatures under 0 ° C, the battery life and performance may degrade. Check more info on Inmotion APP.

## Reminding

At standby status, a fully charged battery will be fully discharged its power in 120-180 days. Usually, the low-power battery should be recharged every 30-60 days. There is a smart chip inside the battery to record the charge and discharge of the battery. All damage caused by overcharging or undercharging is not covered by the warranty.

## Warning

Please do not try to dis-assemble the battery, otherwise, there is a risk of fire. Users are not allowed to repair the parts contained in this scooter by themselves, if without authorization.

## Warning

Do not ride this scooter when the ambient temperature exceeds the product operating temperature (please refer to the parameter table). The extra power lost would be caused by the low / high temperature, meanwhile, slipping or falling may occur, resulting in personal injury or property damage.

For product maintenance, repair, and other related questions, please contact your point of purchase or email to [service@imscv.com](mailto:service@imscv.com).

## 11 Table of Parameters

Specification		Value
Dimension of Product	Unfold: L*W*H	1307*520*1275mm
	Fold: L*W*H	1307*520*560mm
Weight	Net weight	Approx. 24kg
Recommendation	Max. of Payload	140 kg
	For Age at	14+ year
	For Height at	130-200cm
Performance	Max. of Speed	L9: 30km/h; L9G: 20km/h
	Mileage[1]	Approx. 95km
	Max. of Slope	Approx. 30%
	Working temperature	-10— 40°C
	Storage temperature	-20— 45°C
	IP rating	IP55
battery	Charging time	Approx. 7h (single charges), Approx. 3.5h (Dual chargers)
	Rating Voltage	54V
	Max. of Voltage	63V
	Charging temperature	0— 40°C
	Capacity	675Wh
	BMS	Overheat / short circuit / overcurrent / overcharge protection

Motor	Rating power	500W
Charger	Input Voltage	AC100-240V 50/60HZ
	Output Voltage	DC63V
	Output Current	1.8A
Tyre	Front / Rear	10" Pneumatic tire, tubeless
Others	brake light	LED taillight
	Turning light	Sensor-activated automatically
	Ride modes	Eco- mode, D-mode, S-mode

[1] Mileage: Tested under full power, 75kg load, 25 ° C, riding at a cruising speed on a flat road at 18km / h.

## 12 Trademarks and legal notices

Inmotion is a registered trademark of Inmotion Technologies Co., Ltd. ; Android is a trademark of Google; App Store is a sign of Apple service, other trademarks mentioned in this article are belonged by their owners. When printing this manual, it has included as many function introductions and instructions as possible. However, due to the continuous improvement of product functions and design changes, it may still be inconsistent with the product you purchased. Respect. Please scan the QR code on page 6, download the APP for Android or iOS devices, and read the latest version of this manual. Due to product updates, the actual product may deviate from the color and appearance mentioned in this manual. Please refer to the actual product.

All rights reserved by Inmotion Technologies Co., Ltd.

Manufacturer: Inmotion Technologies Co., Ltd.

The more familiar you are with the scooter, the more safety you will get on riding. Therefore we suggest you to:

1. Read this user manual carefully before riding.
2. Do not allow other people to ride this scooter before they read this manual carefully.
3. You are obliged to know all relevant laws, regulations, and policies regarding riding scooters in your area and strictly comply with applicable laws, regulations, and policies.

Safety instructions we suggest you to:

1. Please wear a helmet with an appropriate size when riding.
2. This scooter may contain detachable parts, which should avoid the harm caused by children swallowing.
3. Scooters are similar to other sports equipment, you must be very careful about riding. You must make sure you're able to ride a scooter freely without any assistance, before riding. It is forbidden to ride fatigue, take drugs or drink. It is recommended that you do not ride a scooter during illness, pregnancy, or when you have any bad emotions, chase. No racing and overload.
4. If some damage, emits odor, smoke, overheating or performance failure, or abnormality parts on the scooter, please do not continue to use the scooter and contact with after-sales service in time.
5. When any smoke emitted out from the inside of scooter (even the probability is only 1 in 1 million), please immediately put the scooter into an empty unmanned area, or try to cool down it. Please pay attention to avoid damaging other property or causing any personal injury.
6. Scooter is not medical devices and it's not recommended to be used as medical aids.

7. Do not throw or drop the scooter. Do not place the scooter in an open flame or high temperature.
8. The scooter move spontaneously may be caused by parking without turning off, which may bring damage to others or property around it.
9. The unauthorized modification may endanger your safety on riding, Do not modify the scooter in any form without permission.

#### The requirement of environment for riding:

1. Do not ride on inclined roads, uneven ground, slopes greater than 30%, area near swimming pools and other places with slippery, stagnant water, evacuated materials, etc. which may affect normal riding or not safe. Do not ride in areas where are not permitted to ride by the local laws, regulations or policies.
2. For your safety, please do not take risks to ride through that terrain you have not encountered before, such as steep slopes, inclined roads.
3. Do not ride in the following situations: bad weather, low visibility, at dawn, dusk, thick fog, thick smoke, night or darkness, or extreme fatigue, each of these conditions above would increase the risk of accidents.
4. Do not ride a scooter in rain or snow. After riding, please park the scooter indoors to avoid damage to the scooter due to water ingress caused by rain and snow. Be careful, the resistance of wheels on wet roads is relatively reduced, which will be more difficult for the rider to control the speed.

#### The requirement to rider:

1. The rider must be more than 14 years old and with weight no more than 140 kg. As a parent or guardian, you are responsible for the activities and safety of your minor children. Parents or guardians should accompany the minor children throughout the riding journey to avoid danger.
2. It's not recommended to ride the scooter to persons with difficulties in sight, hearing, body, language, and movement. Anyone with serious heart, high blood pressure, dizziness, and other diseases that are not suitable for sports is strongly recommended not to ride the scooter. No riding on this scooter after taking drugs and alcohol.

## Preparation before riding:

1. Please read this manual carefully. All the components of the scooter must be correctly installed according to the instructions, meanwhile, make sure the installation is not too loose or too tight, to avoid damage or failure.
2. Before riding, please check the installation status, wheel performance, and battery status according to the instruction in manual. Make sure the scooter is a proper status, no signs of loosening or damage on any parts. If any signs of abnormality, please stop riding it immediately and contact the after-sales for checking and guidance.
3. The scooter does not have enough power to maintain your normal riding while the power display is low and empty. Make sure the power is sufficient before riding, in order to avoid any danger.
4. To ride a scooter, you must wear a helmet. And the knee pads, gloves, wrist guards, elbow pads, and sports shoes are recommended.
5. No high heels, slippers, and open-toed shoes when riding a scooter.
6. It is recommended to wear protective glasses on riding, to protect your eyes from dirt, dust, and insects in the air.

## Notes on riding:

1. Please comply with the local laws, regulations, and policies on riding.
2. Start smoothly on a flat road, and do not accelerate or brake sharply on riding, And hold the handle with both hands always.
3. Please be vigilant on riding and always maintain good judgment. Keep a suitable speed and safe distance with other vehicles. Please slow down when driving into an unfamiliar environment.
4. In order to avoid distraction on riding, do not wear headphones, earplugs, make phone calls, take pictures, take pictures.
5. Be defensive about riding. Pay attention to yourself, vehicles, and pedestrians.
6. Make sure you are visible on riding to others.
7. One rider only. Do not ride with others on one scooter, including children and pregnant women.



## Battery maintenance and storage

1. Please use the original battery. Do not use a battery from unauthorized suppliers, otherwise there may be safety risks.
2. Please use the original charger, otherwise, the battery may be damaged or in danger of fire.
3. There are harmful substances in the battery, please do not try to damage or disassemble the battery.
4. If the battery is damaged or gets into water, do not recharge it or continue to use this battery.
5. Do not plug in the charger when the charging port or charging cable is wet.
6. It is strictly forbidden to disassemble, squeeze or puncture the product, forbid touching the battery contacts, disassembling or piercing the casing. Do not put this product into water or fire (including close to the furnace and other heat sources). Avoid short circuits caused by metal objects touching the battery contacts, otherwise it may cause battery damage or personal injury.
7. It is strictly forbidden to immerse the battery and scooter in water or ride in the rain. And do not clear the scooter by the strong water flow and high-pressure hoses. If your scooter has been exposed to heavy rain or has been riding for a long time in the rain, please wipe the scooter with a dry soft cloth in time, stop using it immediately, and consult with the service staff.
8. Do not place the scooter in the environment over 45 °C or below -20 °C (for example, do not put the scooter or battery in a car exposed under the sunshine in summer). Before charging, if the battery was storage under the environment temperature lower than 0 °C, please put the scooter in a warm environment (more than 10°C) for a while until the battery reaches the charging temperature requirement (0-40 °C).
9. Warning: Due to the improper use above, the performance of the battery is attenuated or can not be used normally, which is not covered by the scope of the warranty.
10. The environment may be polluted by the Improper disposal of used batteries. Please comply with the local laws and regulations when discard of the battery.

## Others

1. The data and parameters of the scooter will be varied with different models. It may be subject to change without notice.
2. To the extent permitted by the law, Inmotion reserves the right to interpret and explain this statement. This statement is applied by the laws of the People's Republic of China. Caused by or may cause. With compensation, liability, and loss, Inmotion will not be liable for compensation. Riders shall bear their own responsibility for unforeseen or occurring risks encountered on riding.

Thank you again for your choice and trust in Inmotion.

## 13 Warranty

Thank you for your purchasing of Inmotion products. Please consult the warranty policy with your point of purchase. In case of any assistance needed, please email us: [service@imscv.com](mailto:service@imscv.com).

## FCC Statement

This equipment has been tested and found to comply with the limits for a Class B digital device, pursuant to part 15 of the FCC Rules. These limits are designed to provide reasonable protection against harmful interference in a residential installation. This equipment generates, uses and can radiate radio frequency energy and, if not installed and used in accordance with the instructions, may cause harmful interference to radio communications. However, there is no guarantee that interference will not occur in a particular installation. If this equipment does cause harmful interference to radio or television reception, which can be determined by turning the equipment off and on, the user is encouraged to try to correct the interference by one or more of the following measures:

- Reorient or relocate the receiving antenna.
- Increase the separation between the equipment and receiver.
- Connect the equipment into an outlet on a circuit different from that to which the receiver is connected.
- Consult the dealer or an experienced radio/TV technician for help.

This device complies with part 15 of the FCC Rules. Operation is subject to the following two conditions: (1) This device may not cause harmful interference, and (2) this device must accept any interference received, including interference that may cause undesired operation. Radiation Exposure Statement This equipment complies with FCC radiation exposure limits set forth for an uncontrolled environment. This transmitter must not be co-located or operating in conjunction with any other antenna or transmitter.

This equipment should be installed and operated with minimum distance 20cm between the radiator& your body.





Download Inmotion App

Version:V1.0